

OWNER'S MANUAL

THE McINTOSH C 504 STEREO PREAMPLIFIER



VARIOUS REGULATORY AGENCIES REQUIRE THAT WE BRING THE FOLLOWING INFORMATION TO YOUR ATTENTION. PLEASE READ IT CAREFULLY.

WARNING: TO PREVENT FIRE OR SHOCK HAZARD, DO NOT EXPOSE THIS UNIT TO RAIN OR MOISTURE.

The McIntosh you have purchased is a Model C 504. It has a serial number located on the rear panel of the chassis. Record that serial number here:

Serial Number

The model, serial number and purchase date are important to you for any future service. Record the purchase date here:

Purchase date

Upon application, McIntosh Laboratory provides a Three-Year Service Contract. Your McIntosh authorized Service Agency can expedite repairs when you provide the Service Contract with the instrument for repair. To assist, record your Service Contract number here:

Service Contract Number

Your C 504 Stereo Preamplifier will give you many years of pleasant and satisfactory performance. If you have any questions, please contact:

CUSTOMER SERVICE

**Mcintosh Laboratory Inc.
2 Chambers Street
Binghamton, New York 13903
Phone: 607-723-3512**

**Take Advantage of 3 years
of Contract Service-
Fill in the Application NOW.**

Contents

- INSTALLATION 2, 3
- HOW TO CONNECT AND
BACK PANEL INFORMATION 4
- FRONT PANEL INFORMATION
AND USE OF CONTROLS 6, 7
- PERFORMANCE LIMITS 8
- PERFORMANCE CHARTS 9
- TECHNICAL DESCRIPTION 10
- BLOCK DIAGRAM 12, 13

McINTOSH THREE YEAR SERVICE CONTRACT

An application for A THREE YEAR SERVICE CONTRACT is included with this manual.

The terms of the contract are:

1. McIntosh will provide all parts, materials and labor needed to return the measured performance of the instrument to the original performance limits. The SERVICE CONTRACT does not cover any shipping costs to and from the authorized service agency or the factory.
2. Any McIntosh authorized service agency will repair McIntosh instruments at normal service rates. To receive service under the terms of the SERVICE CONTRACT, the SERVICE CONTRACT CERTIFICATE must be presented when the instrument is taken to the service agency.
3. Always have service done by a McIntosh authorized service agency. If the instrument is modified or damaged as a result of unauthorized repair, the SERVICE CONTRACT will be cancelled. Damage by improper use or mishandling is not covered by the SERVICE CONTRACT.
4. The SERVICE CONTRACT is issued to you as the original purchaser. To protect you from misrepresentation, this contract cannot be transferred to a second owner.
5. To receive the SERVICE CONTRACT, your purchase must be made from a McIntosh franchised dealer.
6. Your completely filled in application for the SERVICE CONTRACT must be postmarked within 30 days of the date of purchase of the instrument.
7. To receive the SERVICE CONTRACT, all information on the application must be filled in. The SERVICE CONTRACT will be issued when the completely filled in application is received by McIntosh Laboratory Incorporated in Binghamton, New York.



mended minimum space for installation is 15 inches (38.1 cm) deep, 17 inches (43.2 cm) wide, and 4 ½ inches (11.4 cm) high.

To install the instrument in a McIntosh cabinet, follow the instructions that are enclosed with the cabinet. For any other type of installation follow these instructions:

1. Open the carton and remove the PANLOC brackets, hardware package, and mounting template from the carton. Remove the C 504 from its plastic bag and place it upside down on the shipping pallet; unscrew the four plastic feet from the bottom of the chassis.

2. Mark the cabinet panel.

Place the mounting template in the position on the cabinet panel where the instrument is to be installed, and tape it in place. The broken lines that represent the outline of the rectangular cutout also represent the outside dimensions of the chassis. Make sure these lines clear shelves, partitions, or any equipment. With the template in place, first mark the six A and B holes and the four small holes that locate the corners of the cutout. Then, join the four corner markings with pencil lines, using the edge of the template as a straightedge.

3. Drill Holes.

Use a drill with a 3/16 inch bit held perpendicular to the panel and drill the six A and B holes. Then, using a drill bit slightly wider than the tip of your saw blade, drill one hole at each of two diagonally opposite corners. The holes should barely touch the inside edge of the penciled outline. **Before taking the next step, make sure that the six A and B holes have been drilled.**

4. Saw the Panel Cutout.

Saw carefully on the inside of the penciled lines. First make the two long cuts and then the two short cuts. After the rectangular opening has been cut out, use a file to square the corners and smooth any irregularities in the cut edges.

The PANLOC system of installing equipment conveniently and securely is a product of McIntosh research. By depressing the two PANLOC buttons on the front panel, the instrument can be locked firmly in place or it can be unlocked so that the chassis can slide forward, giving you easy access to the top and rear panels.

The trouble-free life of an electronic instrument is greatly extended by providing sufficient ventilation to prevent the buildup of high internal temperatures that cause deterioration. Allow enough clearance so that cool air can enter at the bottom of the cabinet and be vented from the top. With adequate ventilation the instrument can be mounted in any position. The recom-

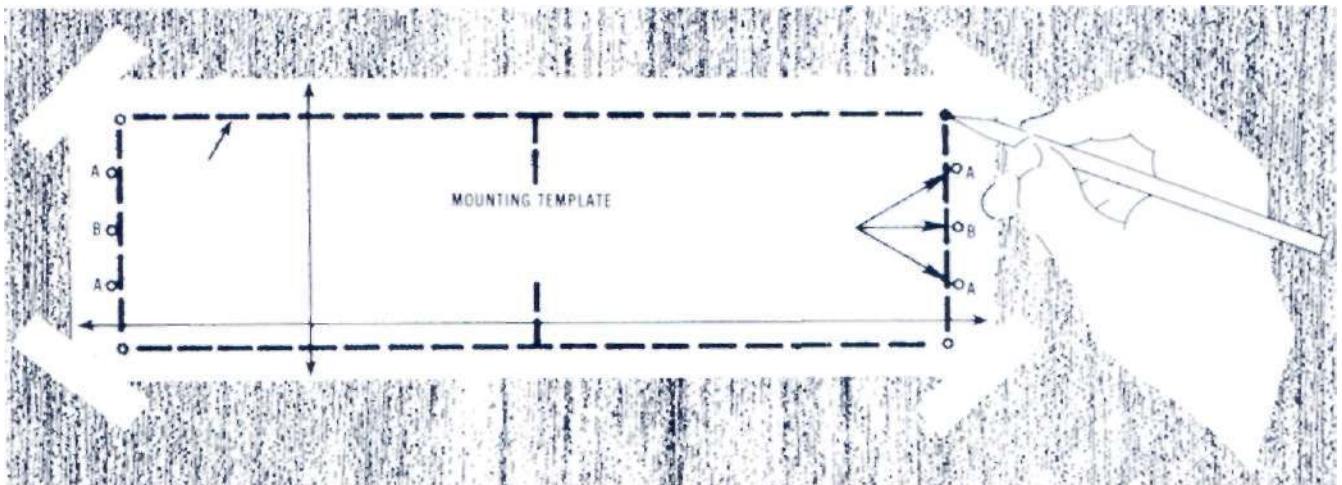

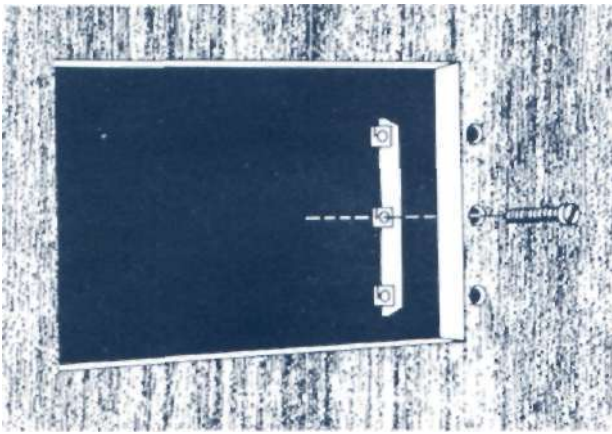

5. Install the Mounting Strips.

In the hardware package you will find two mounting strips, four 6-32 x 1-1/4 inch fillister head screws and two 4-40 x 1-1/4 inch flat head screws. These are long enough for any cabinet panel thickness up to one inch.

Starting at the right-hand side of the panel, insert a 4-40 x 1-1/4 inch flat head screw into the center hole in the panel, marked B on the template. On the back of the panel, align a mounting strip with the holes in the panel and tighten the screw until the screwhead is pulled slightly into the wood.

Repeat this procedure to attach the mounting strip to the left side of the panel.

6. Attach the PANLOC Brackets.

Using two of the 6-32 x 1-1/4 inch fillister head screws in the A holes on each side, attach the PANLOC brackets to the cabinet panel; the short flange is mounted against the front (face) of the cabinet panel.

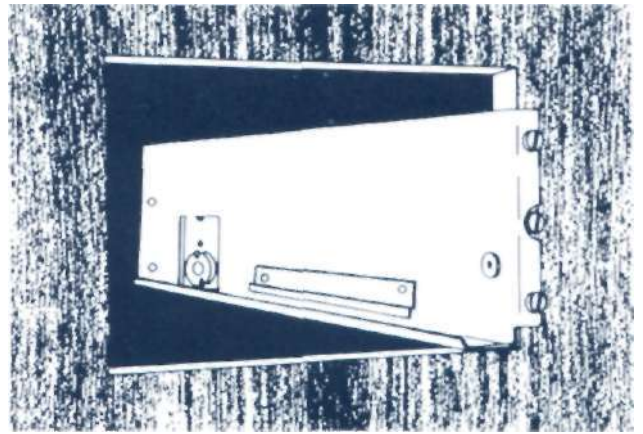

The screws pass through the PANLOC bracket flange, the cabinet panel, and then through the mounting strips previously mounted.

7. Install the Instrument.

Guide the AC power cord through the panel opening to the back of the cabinet; then, slide the instrument into the opening carefully so that the rails on the bottom of each side of the chassis engage the tracks on the mounting brackets. Continue to slide the instrument into the cabinet until it is stopped by the adjust position latches. Press the latches inward, this permits the instrument to slide into the cabinet until its front panel is flush with the cabinet panel. Depress the PANLOC buttons at the lower left and right corners of the instrument panel to lock the unit firmly in the cabinet. Depressing the PANLOC buttons again will unlock the instrument so that it can slide forward to the adjust position; if you press inward on the adjust position latches then you can remove the instrument from the cabinet.

How to Connect and Back Panel Information



Refer to the drawing on page 5.

Rear panel input jacks are provided for a stereo high level source (AUX), 2 stereo turntables (PH 1 and PH 2), 2 stereo tape recorders (TAPE 1 and TAPE 2), and a stereo tuner.

Rear panel output jacks are provided to feed 2 stereo tape recorders (TAPE 1 and TAPE 2), and a stereo power amplifier (MAIN).

A Front panel headphone jack is provided which is fed by an amplifier in the C 504.

CONNECTING TURNTABLES

Connect the cable from the left channel of the turntable into the INPUT PHono 1 Left jack. Connect the cable from the right channel of the turntable into the INPUT PHono 1 Right jack. The C 504 has shorting plugs in the Phono 2 inputs to prevent unwanted noise. Remove the shorting plugs from the input jacks only when they are to be used. For a second turntable, connect PHono 2 in the same way, after removing the shorting plugs.

CONNECTING TAPE RECORDERS

To Record:

Connect a cable from the OUTPUT TAPE 1 Left jack to the left high level input of the tape recorder. Connect a cable from the OUTPUT TAPE 1 Right jack to the right high level input of the tape recorder. Connect a second recorder in the same manner to the OUTPUT TAPE 2 jacks.

To Playback/Monitor:

Connect a cable from the left channel output of a tape recorder to the TAPE INPUT 1 Left jack. Connect a cable from the right channel output of a tape recorder to the TAPE INPUT 1 Right jack. Connect a second recorder in the same manner to the TAPE INPUT 2 jacks.

CONNECTING A STEREO TUNER

Connect a cable from the left tuner output to the L TUNER INPUT jack. Connect a cable from the right tuner output to the R TUNER INPUT jack.

CONNECTING AUX

Connect the left channel cable from any high level source (tuner, TV set, tape recorder, etc.) to the INPUT AUX left jack. Connect the right channel cable to the INPUT AUX Right jack.

CONNECTING TO POWER AMPLIFIERS

Connect the jacks labeled "OUTPUTS MAIN" to the input of a stereo power amplifier. The Left MAIN jack is connected to the left amplifier input jack. The Right MAIN jack is connected to the right amplifier input jack.

CONNECTING PROGRAM SOURCE GROUNDS

A single GROUND post is provided to which grounds for turntables, record changers, tape decks, etc. are connected. To prevent hum pickup, the left and right program cables and the ground wire from that source should be wound or twisted together. Make sure the ground wire does not make any connection to the shields of the left and right program cables between the source and the input of the C 504.

AC POWER OUTLETS

There are 4 black AC power outlets, and 2 red AC power outlets. The AC power to the black outlets is controlled by the front panel switch. Use these outlets for a power amplifier, tuner, tape recorders, etc. The red receptacles are on at all times. Use the red outlets for turntables or record changers. Turntables are protected by this arrangement. It is necessary to turn off a turntable or record changer with its own AC power switch.

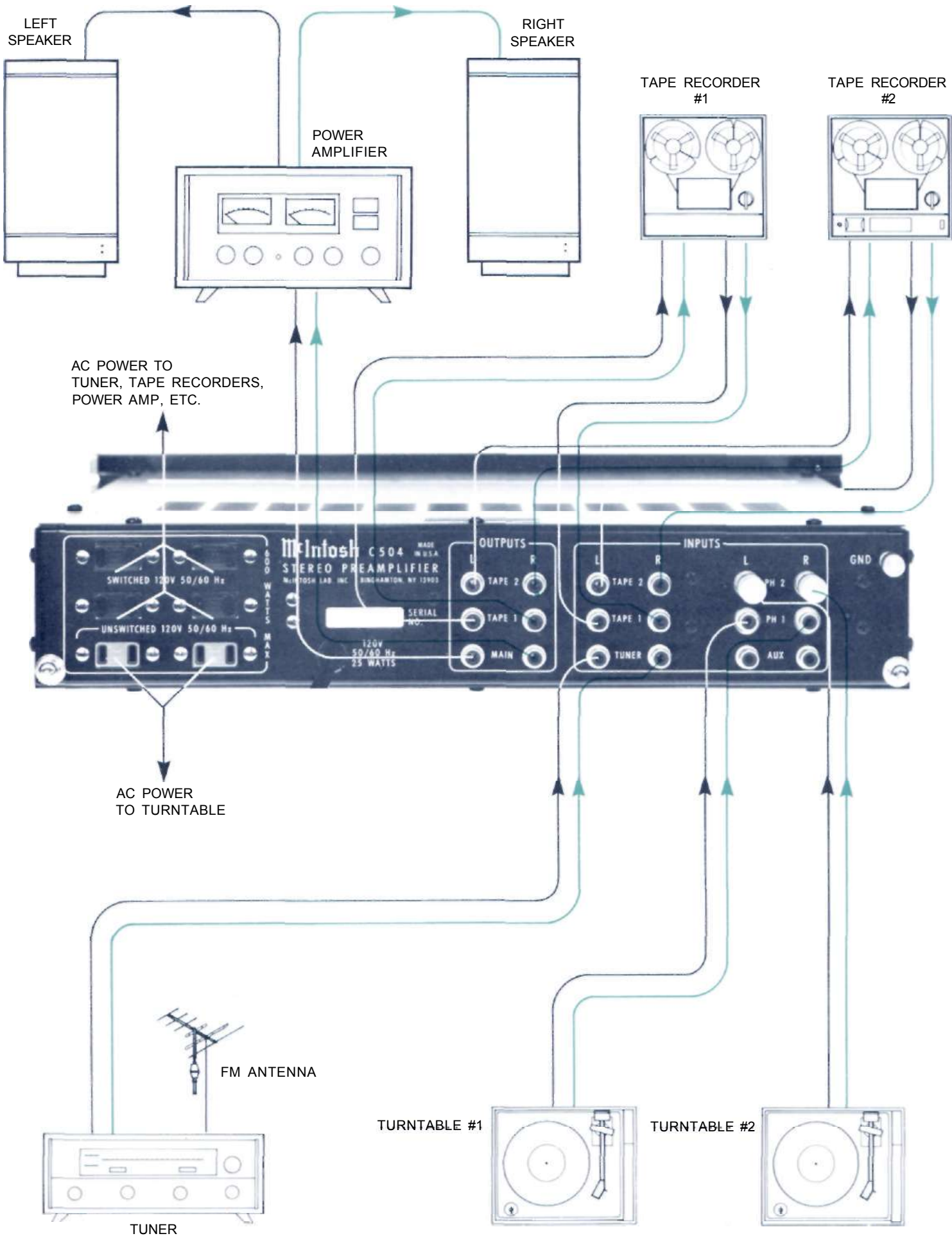

Front Panel Information and Use of Controls

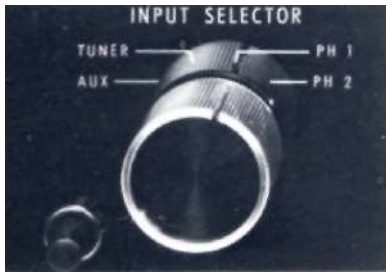

INPUT SELECTOR

The four position INPUT SELECTOR chooses the input program selected. The INPUT SELECTOR is turned to:

AUX: Connects the output from any high level program source requiring flat amplification connected to the Aux input jacks to the high level input stage. Such a source could be another tape recorder, a television set, etc.

TUNER: Connects the output from an AM or FM tuner to the high level input stage. In this position the C 504 has flat amplification.

PHono 1: Connects the output of a magnetic phono cartridge plugged into PHono 1 to the phono amplifying stages. The response of these stages has been shaped to precisely conform to RIAA standards.

PHono 2: Same as PHono 1 for a second turntable.

PUSHBUTTONS



POWER ON: The POWER ON pushbutton energizes the C 504 circuits and connects power to the black AC power outlets on the rear panel.

The C 504 is designed so it may be used with two tape recorders. The four center pushbuttons on the front panel control the signal to and from these recorders. They permit playback of either recorder, monitor of either recorder as recordings are being made, or copying of tapes from one recorder to another while listening to a separate program.

MONITOR TAPE 1 pushbutton out: The program source as selected by the INPUT SELECTOR is fed to the power amplifiers and heard through the loudspeakers. **Pushbutton in:** Signal from a tape recorder plugged into TAPE 1 IN is fed to the power amplifiers and heard through the loudspeakers.

MONITOR TAPE 2 pushbutton: Functions similarly to MONITOR TAPE 1 for a second tape recorder.

IMPORTANT: When the C 504 is operated with either MONITOR pushbutton at the in position, the program heard will be that from the tape recorders only. Signal from any other source will not be heard. To hear any other source, make sure the MONITOR pushbuttons are OUT.

The MONITOR switches are mechanically interlocked to prevent simultaneous monitoring from two tape recorders. If one button is at the in position, it must be pushed again to release it to the out position before the other button can be pushed.

TAPE COPY T1 → T2 pushbutton out: The program source selected by the INPUT SELECTOR is fed to the input of tape recorder 2. **Pushbutton in:** Connects the output from tape recorder 1 to the input of tape recorder 2 without affecting the program being heard from the speakers. In this position a copy of the program on tape recorder 1 can be made on tape recorder 2. To monitor the original use MONITOR TAPE 1



pushbutton and to monitor the copy use MONITOR TAPE 2 pushbutton.

TAPE COPY T2 → T1 pushbutton out: The program source selected by the INPUT SELECTOR is fed to the input of tape recorder 1. Pushbutton in: Connects the output from tape recorder 2 to the input of tape recorder 1 without affecting the program being heard from the speakers. In this position a copy of the program on recorder 2 can be made on recorder 1. To monitor the original use MONITOR TAPE 2 pushbutton and to monitor the copy use MONITOR TAPE 1 pushbutton.

MONO: The MONO pushbutton switches the audio circuits from stereo mode to MONO. The program heard will be monophonic. The TAPE OUT jacks are not affected by the MONO pushbutton.

EQUALIZER FREQUENCY CONTROLS

Each of three EQUALIZER FREQUENCY controls modifies upward or downward the tone balance of a band of frequencies centered on the frequency marked above the control. The flat position of the control has a detent for easy reference. Each control provides 12 dB boost or cut at the specified center frequency.

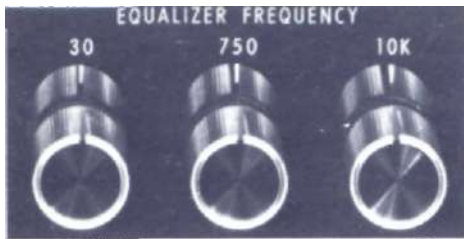

Use the EQUALIZER FREQUENCY controls to modify the sound and tone balance of program material. Here are some suggestions from which to start:

Problem	Equalizer Correction
Bass too weak	Raise 30
Male vocalist needs reinforcing	Raise 30
Hum on program	Reduce 30
Female vocalist reinforcing	Raise 750
Violins, trumpets dull	Raise 750
Drum "brushes" not audible	Raise 10 K
Hiss and/or noise on program	Reduce 10 K



BALANCE and LOUDness

The BALANCE and LOUDness controls are concentric. The BALANCE control (large outer knob) adjusts for equal volume of either the left or right channels.

left...turning the control to the left accents the left channel by reducing the right channel output.

right...turning the control to the right accents the right channel by reducing the left channel output.

The LOUDness control (small center knob) increases both bass and treble frequencies of both channels as it is turned clockwise. Adjustment of the LOUDness control allows life-like frequency balance when playing music softly. Its contour is the same, regardless of the position of the volume control. This contour is accurately modeled after the family of "Equal Loudness" curves identified by Fletcher and Munson. The flat response position of the control has a detent for easy reference.

The loudness circuitry is completely independent of the volume control. Therefore, any desired amount of compensation can be introduced regardless of volume control position.

VOLUME CONTROL

The VOLUME control is a precision step control manufactured for McIntosh Laboratory. It has 32 steps with a 70 dB range, plus volume off. Left and right channel tracking are within



1 dB. This extreme accuracy is obtained through special electronically controlled resistance element trimming. Tracking accuracy is permanently maintained and operation is noise free.

HEADPHONE JACK

A HEADPHONE jack is provided to drive low impedance dynamic headphones from an internal power amplifier.



The volume of the channels can be varied relative to each other without affecting their combined volume.

Performance Limits

Performance Limits

Performance limits are the maximum deviation from perfection permitted for a McIntosh instrument. We promise you that when you purchase a new C 504 from a McIntosh Franchised dealer it will be capable of performance at or exceeding these limits or you can return the unit and get your money back. McIntosh is the only manufacturer that makes this statement.

FREQUENCY RESPONSE

+ 0 -0.5 db from 20 Hz to 20 kHz

RATED OUTPUT LEVELS

Main Out	2.5V
Headphone	750mV
Tape Out	250mV

DISTORTION

0.02% maximum at 2.5V output from 20 Hz to 20 kHz

INPUT SENSITIVITY AND GAIN

Input to Main Out

Phono 1 and 2 2.2mV in for 2.5V out
(61.1 dB gain at 1 kHz)

Tuner, Tape 1 and 2, Aux

250mV in for 2.5V out
(20 dB gain at 1 kHz)

Input to Headphone Out

Phono 1 and 2 2.2mV in for 750mV out
(50.7 dB gain at 1 kHz)

Tuner, Tape 1 and 2, Aux

250mV in for 750mV out
(9.5 dB gain at 1 kHz)

Input to Tape Out

Phono 1 and 2 2.2mV in for 250mV out
(41.1 dB gain at 1 kHz)

Tuner, Tape 1 and 2, Aux

250mV in for 250mV out
(0 dB gain at 1 kHz)

SIGNAL TO NOISE

Phono 1 and 2 -90 dB IHF A-weighted,
below 10mV input
-80 dB unweighted,
below 10mV input

Tuner, Tape 1 and 2, Aux

- 100 dB IHF A-weighted,
below 250mV input
-90 dB unweighted,
below 250mV input

INPUT IMPEDANCE

Phono 1 and 2	47k Ω and 50pF
Tuner, Tape 1 and 2, Aux	47k Ω

OUTPUT IMPEDANCE

Main Out	less than 100 Ω (to operate into 5k Ω or greater)
Headphone	8 Ω
Tape Out	less than 200 Ω (to operate into 5k Ω or greater)

EQUALIZER CONTROL RESPONSE

Center Frequencies	30, 750, and 10 kHz
Boost and Cut	\pm 12 dB

GENERAL INFORMATION

POWER REQUIREMENT

120 Volts 50/60 Hz, 25 Watts

SEMI CONDUCTOR COMPLEMENT

15 Transistors
14 Field Effect Transistors
11 Silicon Diodes
11 Integrated Circuits

MECHANICAL INFORMATION

SIZE

SIZE: Front panel measures 16 inches wide (40.6 cm) by 3 5/8 inches high (9.2 cm). Chassis measures 14 3/4 inches wide (37.5 cm) by 2 3/8 inches high (6.0 cm) by 14 1/2 inches deep (36.8 cm), including connectors. Knob clearance required is 1 1/4 inches (3.2 cm) in front of mounting panel.

FINISH:

Front panel is anodized gold and black with special gold/teal nomenclature illumination. Chassis is black.

MOUNTING:

Exclusive McIntosh developed professional PANLOC

WEIGHT:

14 pounds (6.4 kg) net, 25 pounds (11.3 kg) in shipping carton.

Performance Charts

EQUALIZER FREQUENCY RESPONSE:
CONTROLS SET AT MAXIMUM
AND MINIMUM

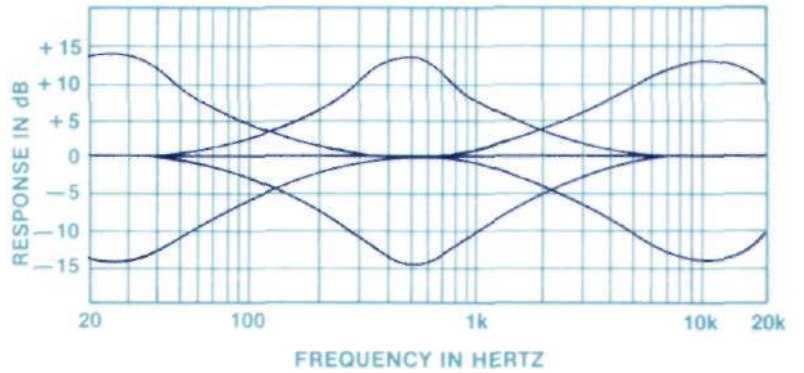

LOUDNESS CONTROL RESPONSE:
FOR VARIOUS CONTROL
POSITIONS

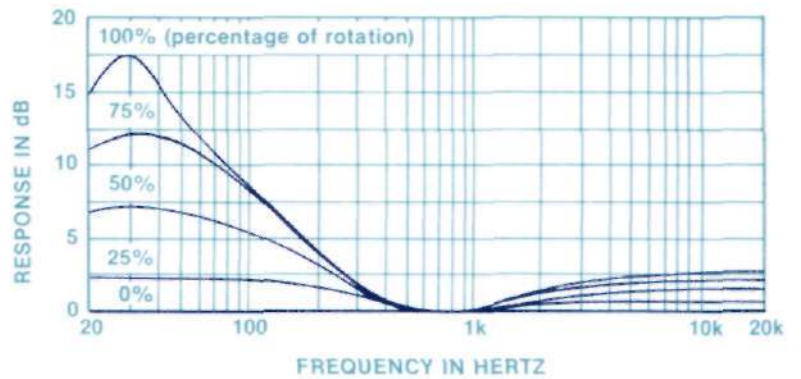

HARMONIC DISTORTION:
IN: AUX; OUT: MAIN

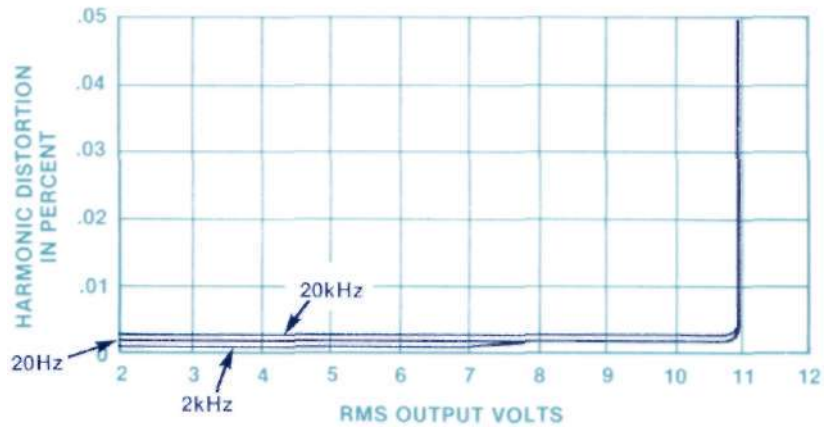

INTERMODULATION DISTORTION:
IN: AUX; OUT: MAIN
INPUT FREQUENCY: 60 Hz & 7 kHz:
RATIO: 4:1

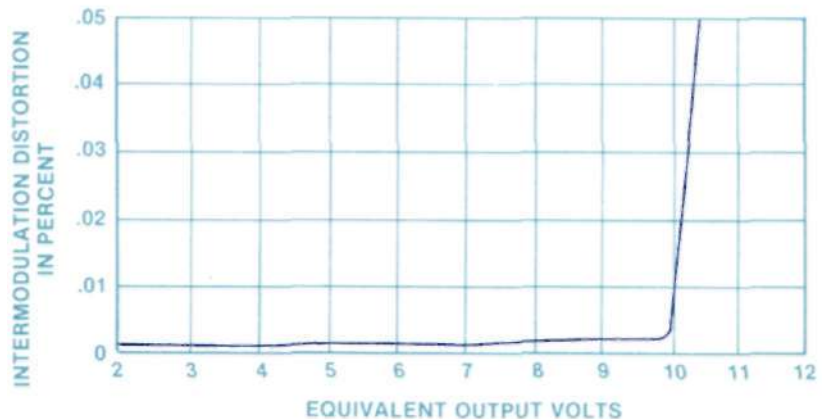

Technical Description

The C 504 is comprised of six basic sections. They are: phono amplifier, high level amplifier, equalizer amplifier, output/headphone amplifier, input selector switching, and power supply. Their circuit descriptions follow.

PHONO AMPLIFIER

The phono amplifier uses a high technology integrated circuit operational amplifier. Its differential input stage has been optimized for low noise and low distortion performance. Open loop gain of this integrated circuit is 100,000. With high open loop gain a large amount of negative feedback can be used around the phono amplifier to further reduce noise and distortion. The feedback network also provides precision RIAA frequency compensation. The network uses 1% metal film resistors and 5% poly film capacitors. To achieve low noise performance it is essential that the feedback network have very low impedance. As a consequence, the preamplifier must be capable of operating as a power amplifier to drive this impedance. The actual power output capability of this preamplifier stage is more than 100 milliwatts, a great margin beyond that which is required.

Input sensitivity of the phono amplifier is 2.2 millivolts. The gain of the amplifier is 41.1 dB at 1000 Hz. The phono amplifier has a very wide dynamic range. At 1000 Hz the phono input circuit will accept

100 millivolts without overload, a voltage far greater than the output of any current magnetic phono cartridge. Phono input overload therefore is virtually impossible. A signal level of 10 millivolts at the phono input at 1000 Hz will produce 1.13 volts at the tape output. The tape output has a source impedance of 200 ohms and is designed to operate into a load impedance of 5,000 ohms or greater.

HIGH LEVEL AMPLIFIER

At the input to the high level or loudness amplifier the signal passes through the MONO/stereo switch, then through the volume control, and into the amplifier. In the past, loudness controls have typically used simple passive circuits connected to a tap on the volume control. As a consequence, compensation accuracy was dependent on many variables such as volume control position and differences in the input level. The C 504 uses active circuitry. The same type of integrated circuit operational amplifier that is used in the phono amplifier is used here. It has two feedback loops. One feedback loop is flat. The other feedback loop conforms to the Fletcher-Munson equal loudness compensation. A potentiometer is placed between these two feedback loops making it possible to select any combination of the two from a flat response to full loudness compensation. The overall gain of the stage is 20 dB at mid-frequencies and is



not affected by the position of the loudness control.

EQUALIZER AMPLIFIER

The equalizer amplifier is constructed with another of the same type low noise operational amplifier as used in the phono amplifier. Three other operational amplifiers are arranged in circuit configurations that are the equivalent of three series tuned circuits. One is resonant at each of the three equalizer center frequencies. These series tuned circuits are inserted via the control potentiometers in either the input circuit or feedback circuit of the equalizer amplifier thereby providing a boost and cut capability of 12 dB for each band of frequencies. The equalizer amplifier has a flat response gain of 0 dB.

OUTPUT/HEADPHONE AMPLIFIER

The output amplifier is a push-pull complementary class AB amplifier using a signal inverting differential stage at its input. This amplifier drives the main outputs and the headphone jack. More than 10 volts RMS output can be produced with typically no more than 0.003% harmonic distortion.

A turn-on delay circuit is located ahead of the output amplifier. This circuit uses a light emitting diode/light dependent resistor network that functions to transmit no signal until two seconds after the power switch is turned on and to remove the output signal almost instantly upon power turn-off. Thus the turn-on and turn-off is transient and noise free.

INPUT SELECTOR SWITCHING

Low level, noise critical input selector switching is done electronically using field effect transistor analog switches. The front panel selector simply switches small amounts of control DC which turn the FET analog switches off or on. This design eliminates degradation of frequency response and noise pickup from long signal paths necessary with conventional switching.

POWER SUPPLY

To minimize magnetic hum radiation and thus improve signal to noise ratio the C 504 power transformer is triple shielded. Shielding includes a copper strap, a silicon steel strap, and finally a steel outer shell. The transformer output voltage is fed to a full wave bridge rectifier and 3,300 microfarad filter capacitors to provide the +24 volts for powering the plus regulator and -24 volts for the minus regulator. Integrated circuit voltage regulators supply the ± 18 volts needed for low level amplifier stages.

Block Diagram

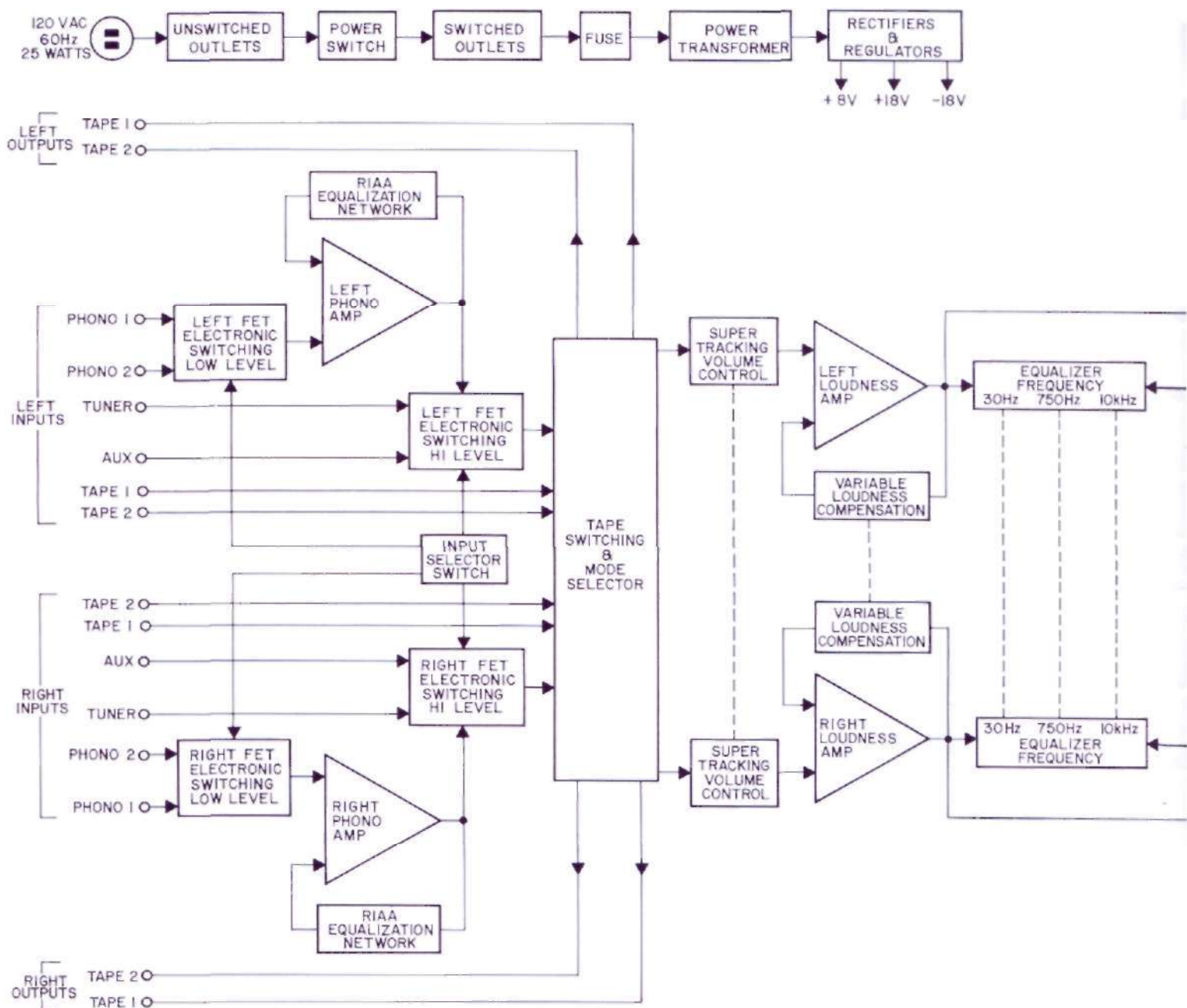

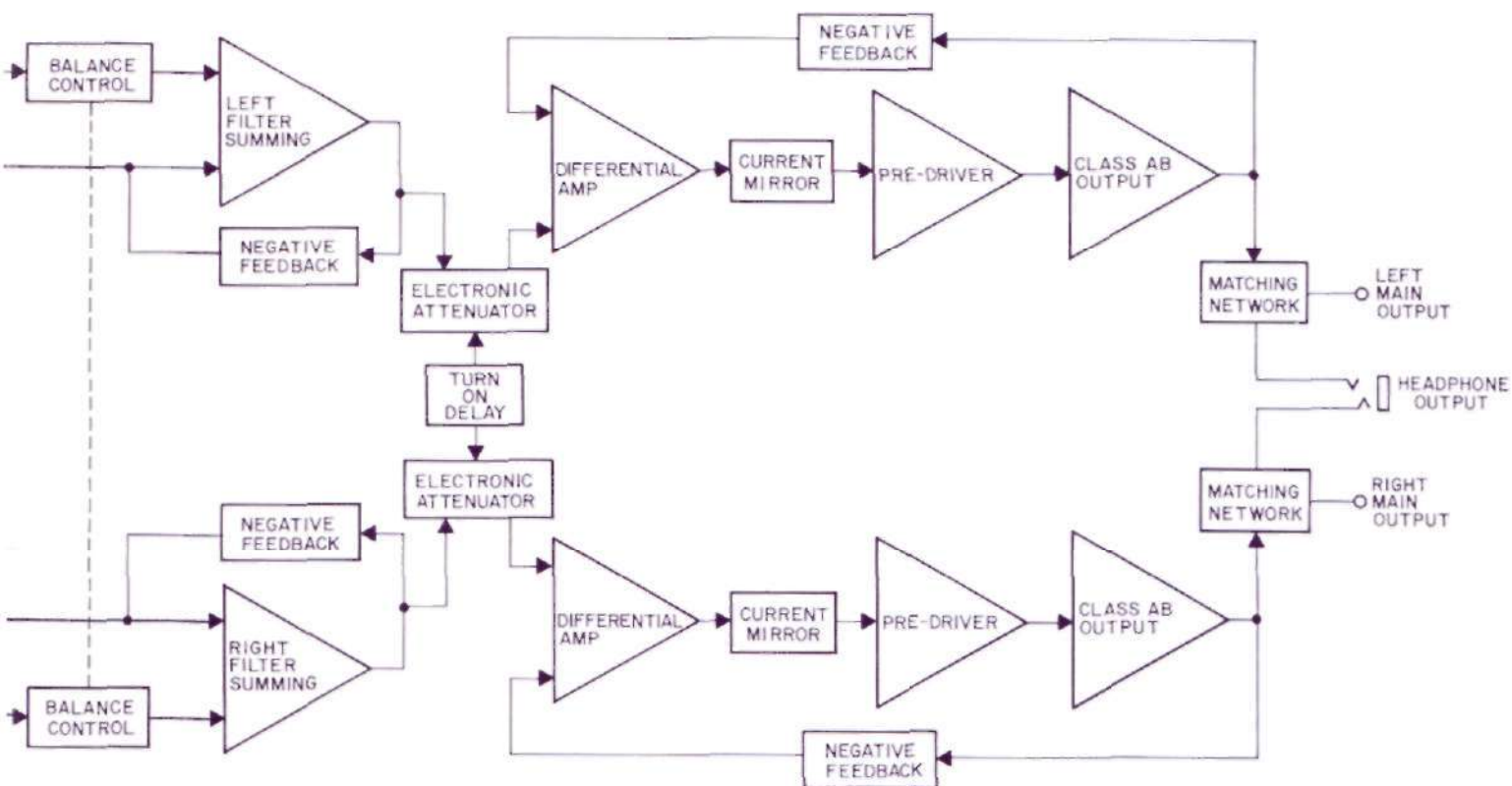

McIntosh

**McINTOSH LABORATORY INC.
2 CHAMBERS ST., BINGHAMTON, N.Y. 13903**

607-723-3512

The continuous improvement of its products is the policy of
McIntosh Laboratory Incorporated who reserve the right to
improve design and price without notice.

Printed in U.S.A.

039243